

CERTIFICATES



RAAD  [®]
Confidence in Connection

İÇİNDEKİLER

- 5 RTP Ex Serisi Klemensler
- 6 RET Serisi Topraklama Klemensleri
- 7 İki ve Üç Katlı Klemensler
- 8 PUSH-IN Yay Baskılı Klemensler
- 9 PUSH-IN Bağlantılı Bir Giriş - İki Çıkış ve İki Giriş -İki Çıkış Klemensler
- 10 Ölçme Ayırma Klemensleri
- 11 Ayırma-Birleştirme Klemensleri / Sigortalı Klemensler
- 13 Kablo Kanalları
- 14 Montaj Rayları / Kablo Bağları ve Kanal Kapakları
- 15 Klemens Etiketleri / Grup Etiketleri ve Durdurucular
- 17 Ray Montaj Topraklama Prizi / Led Sinyal Lambaları / Trafo Klemensleri
- 18 Ayırma Plakaları
- 19 Nihayet Plakaları
- 20 Tarak Köprü / Push-in İçin Üst Köprüler
- 21 Vidalı Klemens Üst Köprüleri
- 22 Tarak Köprü ve Test Fişi
- 23 Butonlar
- 25 Sigorta Tutucular ve Sigortaları
- 27 Baralı Klemensler
- 28 Termal Yazıcı ve Aksesuarları
- 29 Kaçak Akım Roleleri
- 30 Otomatik Sigortalar 6 kA
- 31 Otomatik Sigortalar 10 kA
- 32 Bölgelerimiz ve Bayiliklerimiz





Hakkımızda...

Bağlantıda güven; Raad firmasının sloganıdır. Bu sadece bir slogan değil aynı zamanda bizim düşlediğimiz ve derinden inandığımız bir şey.

Raad markası 29 yıllık üretim tecrübesi ve çalışmalarıyla ürünlerini son teknolojiye uygun ve üstün kalite ile kullanıcılara sunmaktadır.

Raad ürünleri; kalite ve güvenilirliğini onaylayan ISO9001 kalite yönetim sistemi ve KEMA, ATEX, VDE CE, TSE gibi uluslararası standart sertifikalarına sahiptir.

Hızla gelişen teknoloji ve iş dünyasına ayak uydurmak ve bunun yanında müşterilerimizi memnun etmek için en modern ekipmanları kullanarak üretim yaptığımız kadar R&D departmanının yaratıcılık ve tecrübelerinden de faydalanarak yeni ürünler geliştirmekteyiz. Raad ürünleri uluslararası standart ve ihtiyaçları karşıladıkça ürünlerinin geniş çapta ihracatı yapılmaktadır.

Raad markası bu katalogta verilen bilgileri değiştirme hakkına sahiptir. Güncel teknik bilgiler ve yeni fiyatlar için lütfen bizimle iletişime geçin.

Raad Elektrik Ticaret Ltd. Şti.

İvedik Organize Sanayi Bölgesi 1436 Cadde No:16 Ostim, Ankara ,Türkiye
Tel: +90 312 436 36 06 Faks: 0312 394 06 05

info@raad.com.tr

www.raad.com.tr

TERMINAL BLOCKS



RAAD  [®]
Confidence in Connection



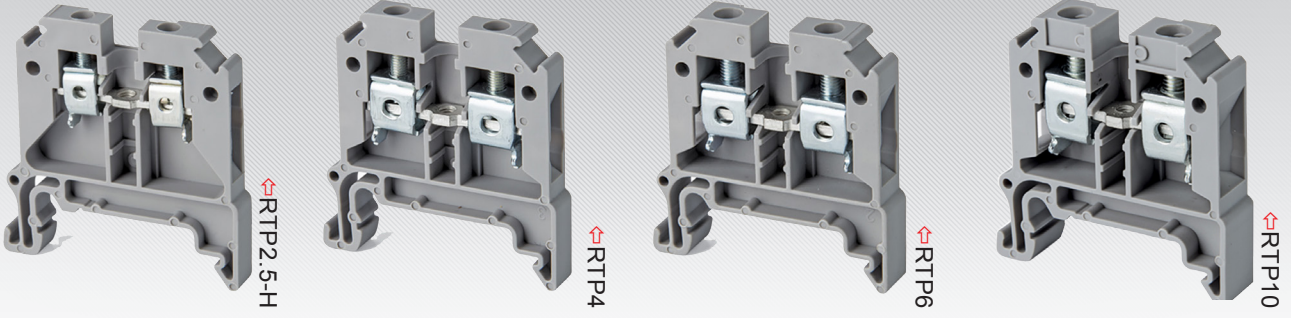

RTP Ex-Serisi Klemensler

Sip. No	Tip	Kesit mm ²	AKIM (A)	Açıklama Renk	Etiket	Miktar Kutu/Koli	Fiyat TL / Adet
6010301001	RTP2,5-H	2.5	24	○●●●●●●●●	NS 6	100/1000	2.25
6010403001	RTP4	4	32	○●●●●●●●	NS 6.4	100/1000	2.80
6010404001	RTP6	6	41	○●●●●●●●	NS 8	50/1000	4.50
6010405001	RTP10	10	57	○●●●●●●●	NS 10	50/1000	6.50
6010406001	RTP16	16	76	●●●●	NS 10	50/500	8.50
6010407001	RTP25	25	101	●●●●	NS 10	50/500	12.50
6010408001	RTP35	35	125	●●●●	NS 10	20 /320	16.50
6010409001	RTP50	50	150	●●●●	NS 10	20/200	51.00
6010411000	RTP70	70	192	●●	NS 10	10/50	72.00
6010411001	RTP95	95	232	●●	NS 10	5/50	91.00
6010412001	RTP150	150	309	●●	NS 10	5/50	116.00

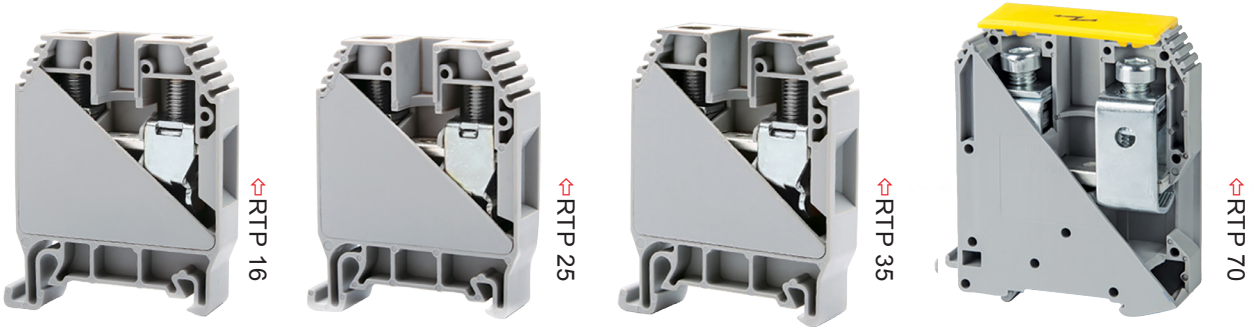

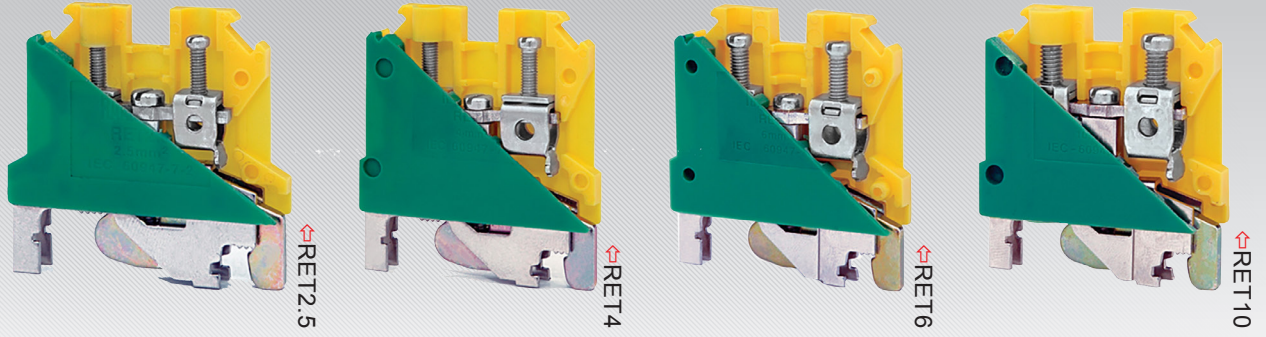

RET Serisi Topraklama Klemensleri

Sip. No	Tip	Kesit mm ²	Açıklama Renk	Etiket	Miktar Kutu/Koli	Fiyat TL / Adet
6010601001	RET2.5	2.5	●●	NS 6	50/500	12.50
6010601002	RET4	4	●●	NS 6.4	50/500	14.00
6010601003	RET6	6	●●	NS 8	25/500	16.25
6010601004	RET10	10	●●	NS 10	25/500	17.50
6010601005	RET16	16	●●	NS 10	20/340	22.00
6010601006	RET35	35	●●	NS 10	20/200	43.00

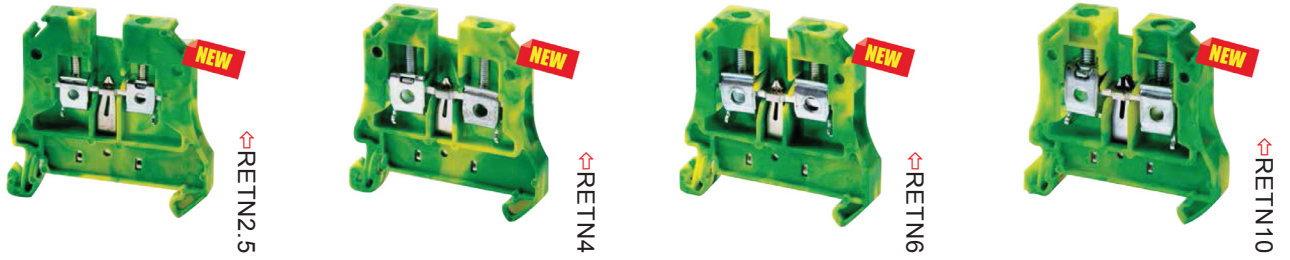

RET Serisi Topraklama Klemensleri

Sip. No	Tip	Kesit mm ²	Açıklama Renk	Etiket	Miktar Kutu/Koli	Fiyat TL / Adet
6010602001	RETN2.5	2.5	●●	NS 6	50/500	8.50
6010602002	RETN4	4	●●	NS 6.4	50/500	9.50
6010602003	RETN6	6	●●	NS 8	25/500	13.50
6010602004	RETN10	10	●●	NS 10	25/500	16.50

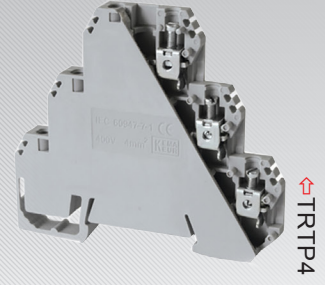
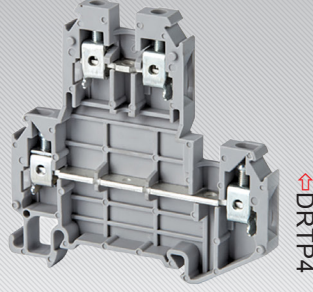
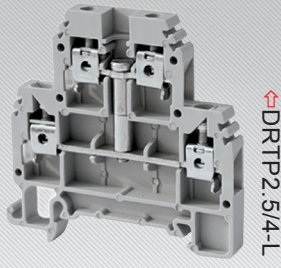
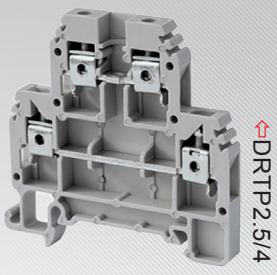

İki ve Üç Katlı Klemensler

Sip. No	Tip	Kesit mm ²	Açıklama Renk	Etiket	Miktar Kutu/Koli	Fiyat TL / Adet
6010728005	DRTP2.5/4	2,5/4	●	NS 6	50/600	7.50
6010728004	DRPT2.5/4-D1 ...D6	2,5/4	●	NS 6	50/600	15.25
6010728003	DRPT2.5/4-L	2,5/4	●	NS 6	50/600	15.25
6010701005	DRTP4	4	●●●●●	NS 6.4	50/800	8.70
6010702005	DRTP4-D1	4	●	NS 6.4	50/800	13.00
6010703005	DRTP4-D2	4	●	NS 6.4	50/800	13.00
6010704005	DRTP4-D3	4	●	NS 6.4	50/800	13.00
6010705005	DRTP4-D4	4	●	NS 6.4	50/800	13.00
6010706005	DRTP4-D5	4	●	NS 6.4	50/800	13.00
6010707005	DRTP4-D6	4	●	NS 6.4	50/800	13.00
6010720005	DRTP4-DR1	4	●	NS 6.4	50/800	13.00
6010721005	DRTP4-DR2	4	●	NS 6.4	50/800	13.00
6010722005	DRTP4-LD	4	●	NS 6.4	50/800	13.00
6010723005	DRTP4-NL	4	●	NS 6.4	50/800	13.00
6010727005	DRTP4-L	4	●	NS 6.4	50/800	14.00
6010729005	DRTP4-R1	4	●	NS 6.4	50/800	13.00
6010750005	TRTP4	4	Üç Katlı Klemensler	NS 6.4	25/500	18.00



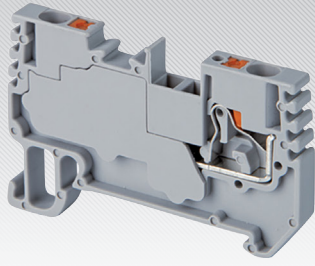

⇨RPIT2.5

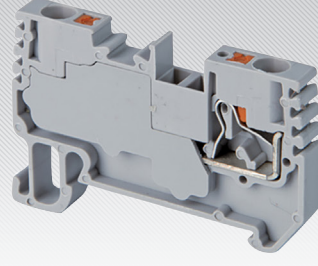

⇨RPIT4

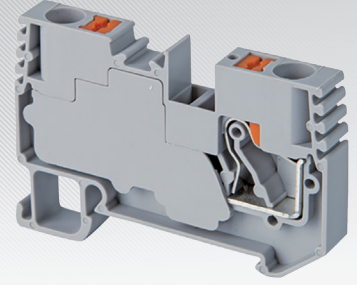

⇨RPIT6

Push-in Bağlantılı Klemensler

Sip. No	Tip	Akım	Kesit mm ²	Açıklama Renk	Etiket	Miktar Kutu/Koli	Fiyat TL / Adet
6011001001	RPIT2.5	24	2.5	●●●●●●●●●●	RTERM	100/1000	2.50
6011002002	RPIT4	32	4	●●●●●●●●	RTERM	100/800	4.00
6011003001	RPIT6	41	6	●●●●●●●●	RTERM	50/500	5.90

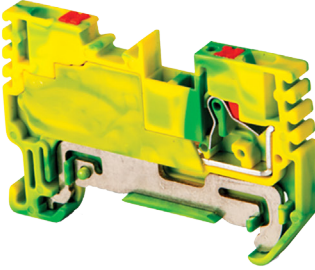

⇨RPET 2.5

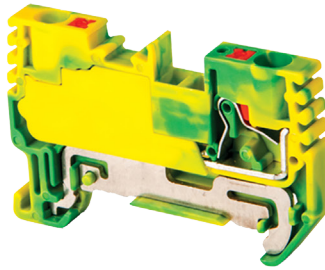

⇨RPET 4

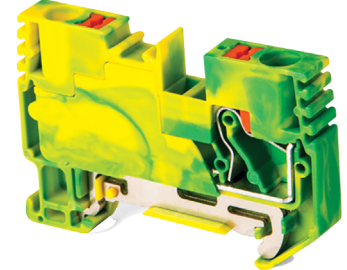

⇨RPET 6

Push-in Bağlantılı Topraklama Klemensleri

Sip No	Tip	Akım	Kesit mm ²	Açıklama Renk	Etiket	Miktar Kutu/Koli	Fiyat TL / Adet
6011201001	RPET2.5	24	2.5	●●	RTERM	50/500	10.50
6011201002	RPET4	32	4	●●	RTERM	50/500	14.00
6011201003	RPET6	41	6	●●	RTERM	25/500	18.00

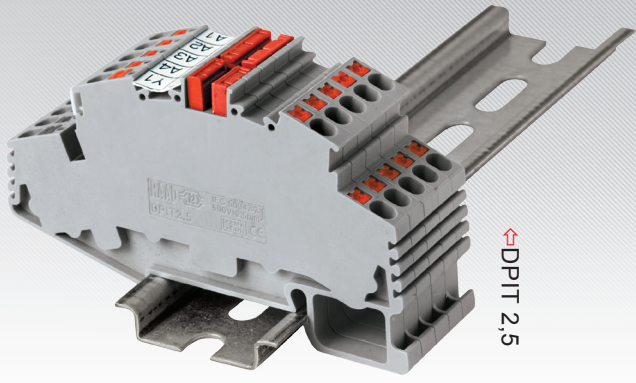

⇨ DPIT 2,5

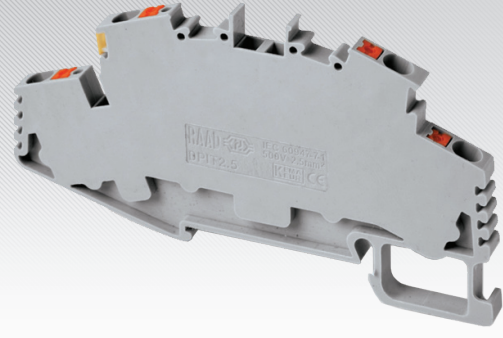

⇨ DPIT 2,5

Push-in Bağlantılı İki Katlı Klemensler

Sip No	Tip	Akım	Kesit mm ²	Açıklama Renk	Etiket	Miktar Kutu/Koli	Fiyat TL / Adet
6011101001	DPIT 2,5	24	2.5	●	RTERM	50/500	8.20

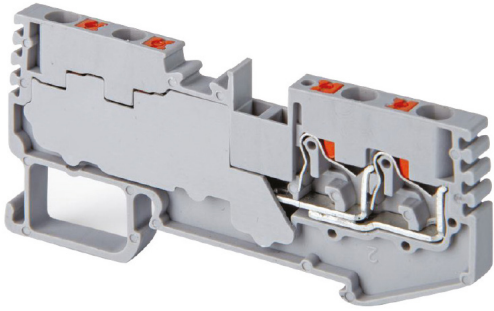

⇨ RPIT 2/2

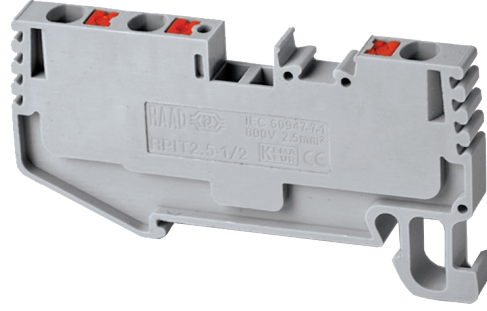

⇨ RPIT 1/2

Push-in Bağlantılı Bir Giriş - İki Çıkış Klemensler

Sip No	Tip	Akım	Kesit mm ²	Açıklama Renk	Etiket	Miktar Kutu/Koli	Fiyat TL / Adet
6011005005	RPIT 1/2	24	2.5	Bir Giriş - İki Çıkış ●	RTERM	40/400	5.90
6011006001	RPIT 2/2	24	2.5	İki Giriş - İki Çıkış ●	RTERM	40/400	7.80

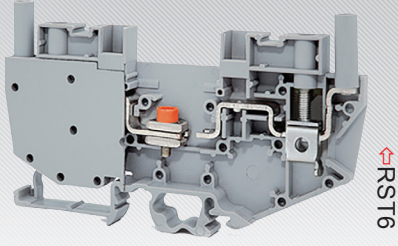

⇨RST6

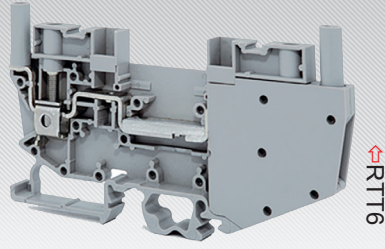

⇨RTT6

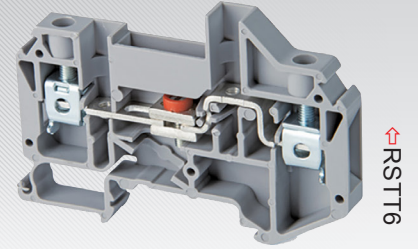

⇨RSTT6

Ölçme-Ayırma Klemensleri

Sip. No	Tip	Kesit (mm ²)	Akım (A)	Etiket	Miktar Kutu/Koli	Fiyat TL / Adet
6010301001	RST6	6	41	NS 8	20/320	22.00
6010302001	RTT6	6	41	NS 8	20/320	31.00
6010303001	RSTT6	6	41	NS 8	25/500	19.00
6010304001	RSTP6	6	41	NS 8	25/500	13.50
6010305001	RSTU6	6	41	NS 8	25/500	19.00
6010306001	RSTN6	6	Çift Kovanlı Klemensler	NS 8	25/500	26.00

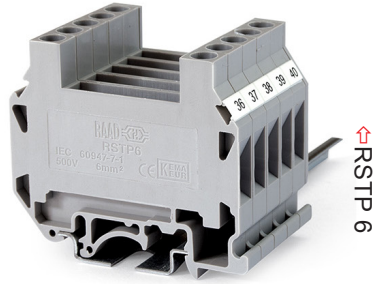

⇨RSTP 6

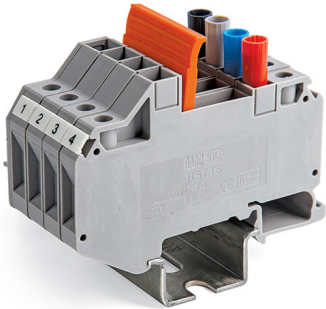

⇨RSTT 6

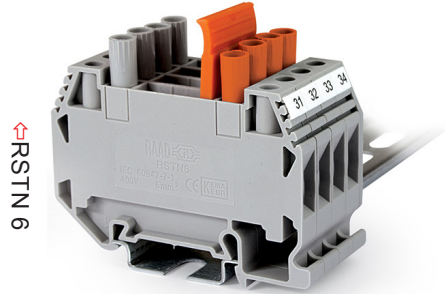

⇨RSTN 6



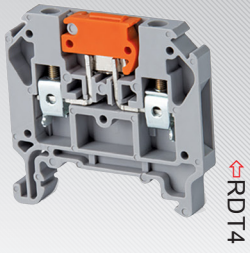

RDT4

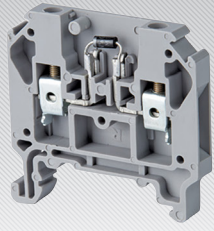

RDT4-D1

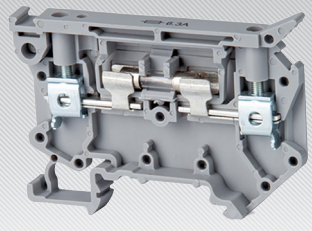

RFT5



RDT2,5-CFC

Ayrırma-Birleştirme Klemensleri

Sip. No	Tip	Kesit mm ²	Akım (A)	Etiket	Miktar Kutu/Koli	Fiyat TL / Adet
6010802001	RDT4	1.5	17.5	NS 6.4	50/1000	11.00
6010802002	RDT4-TS	1.5	17.5	NS 6.4	50/1000	13.50
6010802004	RDT4-R1	1.5	17.5	NS 6.4	50/1000	13.50
6010802003	RDT4-D1	1.5	17.5	NS 6.4	50/1000	13.50
6010801001	RDT2,5-C	1.5	17.5	NS 6	50/900	7.10
6010801002	RDT2,5-CDC	1.5	17.5	NS 6	25/500	16.50
6010801006	RDT2,5-CTS	1.5	17.5	NS 6	25/500	12.50
6010801007	RDT2,5-CRC	1.5	17.5	NS 6	25/500	27.00

Sigorta Klemensler

6010201001	RFT5	4	6.3	NS 8	25/500	13.00
6010202001	RFT5-NL (24-48 VAC/DC)	4	6.3	NS 8	25/500	25.00
6010202002	RFT5-NL (110-220 VAC)	4	6.3	NS 8	25/500	25.00
6010801003	RDT2,5-CFC	1.5	6.3	NS 6	25/500	13.00
6010801004	RDT2,5-CFCLD (24-48 VAC/D)	1.5	6.3	NS 6	25/500	27.50
6010801005	RDT2,5-CFCLD (110-220 VAC)	1.5	6.3	NS 6	25/500	27.50

KABLO KANALLARI

SLOTTED WIRING DUCTS

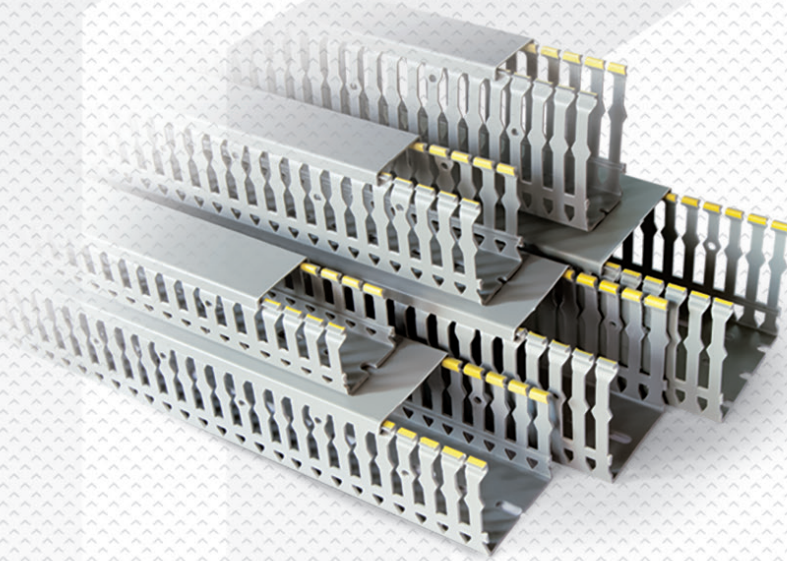

SLOTTED WIRING DUCTS

Duct Nominal size (WxH)mm	Dimensions (mm)						Qty. in Carton	Total Length in carton	Ordering No.
	W	H	E	F	G	φ			
25 x 40	25	40	6.5	5.9	12.8	4.5	30	60	6110105008
40 x 40	40	40	6.5	5.9	12.8	4.5	20	40	6110108008
60 x 40	60	40	6.5	5.9	12.8	4.5	16	32	6110112008
25 x 60	25	60	6.5	6	15.7	4.5	20	40	6110105012
40 x 60	40	60	6.5	6	15.7	4.5	18	36	6110108012
60 x 60	60	60	6.5	6	15.7	4.5	12	24	6110112012
80 x 60	80	60	6.5	6	15.7	4.5	10	20	6110116012
100 x 60	100	60	6.5	6	15.7	4.5	6	12	6110120012
40 x 80	40	80	6.5	6	19.8	4.5	14	28	6110108016
60 x 80	60	80	6.5	6	19.8	4.5	8	16	6110112016
80 x 80	80	80	6.5	6	19.8	4.5	8	16	6110116016
100 x 80	100	80	6.5	6	19.8	4.5	4	8	6110120016
100 x 100	100	100	6.5	6	19.8	4.5	4	8	6110120020

ONFLOOR WIRING DUCTS

TYPE	Dimension (mm)		Qty. in cartoon	Length (m)	Ordering No.
	W	H			
50 x 13	50	13	30	60	6110310010
70 x 18	70	18	14	28	6110310014
90 x 24	90	24	8	16	6110310018

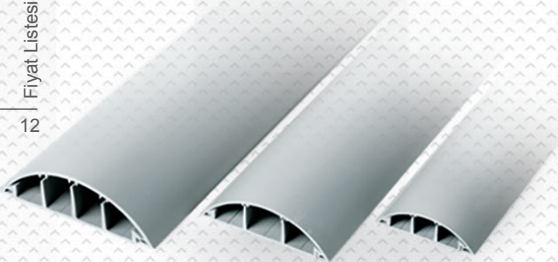

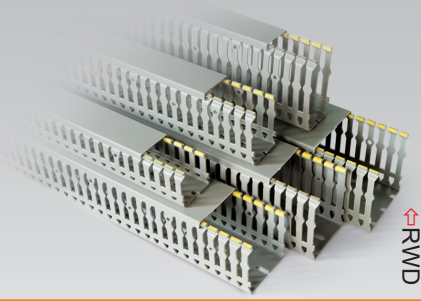

RWD

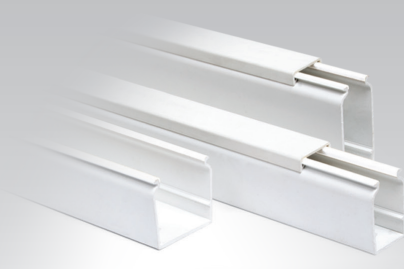

HWD

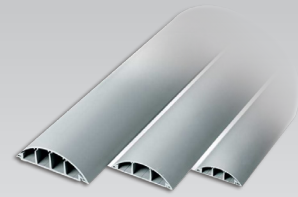

OWD

RWD Serisi Kablo Kanalları

Sip. No	Tip	Boyutlar WxH(mm)	Açıklama	Miktar Metre	Fiyat TL / Metre
6110105008	RWD	25x40	Delikli 2mt	60	9.00
6110105012	RWD	25x60	Delikli 2mt	40	14.00
6110108008	RWD	40x40	Delikli 2mt	40	13.00
6110108012	RWD	40x60	Delikli 2mt	36	17.50
6110108016	RWD	40x80	Delikli 2mt	28	24.00
6110112008	RWD	60x40	Delikli 2mt	32	19.50
6110112012	RWD	60x60	Delikli 2mt	24	25.00
6110112016	RWD	60x80	Delikli 2mt	16	30.00
6110116012	RWD	80x60	Delikli 2mt	20	28.00
6110116016	RWD	80x80	Delikli 2mt	16	35.00
6110120012	RWD	100x60	Delikli 2mt	12	39.00
6110120016	RWD	100x80	Delikli 2mt	16	45.00
6110120020	RWD	100x100	Delikli 2mt	8	51.00

HWD Serisi Kablo Kanalları

6110203002	HWD	20x12	Kapalı 2mt	130	2.66
6110204003	HWD	20x20	Kapalı 2mt	76	2.73
6110205004	HWD	25x20	Kapalı 2mt	72	3.38
6110206006	HWD	30x30	Kapalı 2mt	40	6.24
6110208008	HWD	40x40	Kapalı 2mt	40	8.90
6110212008	HWD	60x40	Kapalı 2mt	36	11.80
6110212012	HWD	60x60	Kapalı 2mt	24	14.50
6110220020	HWD	100x60	Kapalı 2mt	12	18.40

OWD Serisi Kablo Kanalları

60650080	OWD	50x13	Kapalı 2mt	60	8.85
60650082	OWD	70x18	Kapalı 2mt	40	16.00
60650084	OWD	90x24	Kapalı 2mt	20	19.50

www.raad.com.tr

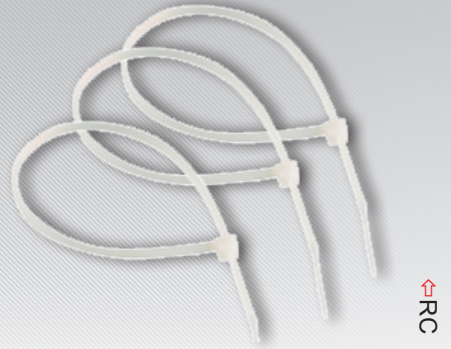
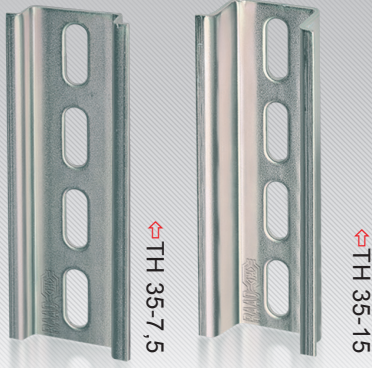

Montaj Rayları

Sip. No	Tip	Ölçü	Açıklama	Miktar Mt	Fiyat TL / Metre
6090101002	TH 35-7.5S RAAD	2 mt	Delikli	80 mt	9.00
6090102002	TH 35-15S RAAD	2 mt	Delikli	40 mt	24.00

Kablo Bağları

Sip. No	Tip	Bağlama Çapı	Açılma Muhavemeti (Kg)	Miktar Adet	Fiyat TL / Adet
6100100010	RC 2,5*100	18 mm	8.1	100/10000	Sorunuz
6100100015	RC 2,5*150	35 mm	8.1	100/10000	Sorunuz
6100200020	RC 2,5*200	50 mm	8.1	100/10000	Sorunuz
6100200025	RC 3,6*200	50 mm	18	100/6000	Sorunuz
6100200030	RC 3,6*250	65 mm	18	100/5000	Sorunuz
6100300040	RC 3,6*300	76 mm	18	100/6000	Sorunuz
6100200045	RC 4,8*400	102 mm	22	100/3000	Sorunuz

Kanal Kapakları

Sip. No	Tip	Ölçü	Miktar Mt	Fiyat TL / Adet
6115050005	RWD 25	2 mt	20/40	2.65
6115050008	RWD 40	2 mt	20/40	2.80
6115050012	RWD 60	2 mt	20/40	4.45
6115050015	RWD 80	2 mt	20/40	6.75
6115050018	RWD 100	2 mt	20/40	8.95

RTP		RET		RST		RTT		RST		RST																																							
151	152	153	154	155	156	157	158	159	160	161	162	163	164	165	166	167	168	169	170	171	172	173	174	175	176	177	178	179	180	181	182	183	184	185	186	187	188	189	190	191	192	193	194	195	196	197	198	199	200
1	2	3	4	5	6	7	8	9	10	1	2	3	4	5	6	7	8	9	10	1	2	3	4	5	6	7	8	9	10	1	2	3	4	5	6	7	8	9	10	1	2	3	4	5	6	7	8	9	10



↕LB/1



↕LB/2



↕ELB/1

Klemens Etiketleri

Sip. No	Tip	Boyut	Uygulama	Miktar Adet/Birim	Fiyat TL / Adet
6030300001	NS 6	6	RTP2,5-H - RET2,5- RDT2,5C-RDT2,5CTS RDT2,5CDC- RDT2,5CFC- RDT2,5CFCLD	50/1	6.50
6030400001	NS 6.4	6.4	RTP4- DRTP4- DRTP4L DRTP4D1-2-3-4-5-6- DRTP4DR- TRTP4	50/1	6.50
6030500001	NS 8	8	RTP6- RET6- RST6- RTT6- RSTT6- RSTU6 RSTP6- RFT5- RFT5NL- RFT5LD	50/1	6.50
6030600001	NS 10	10	RTP10-16-2,5-35-50-95-150 RET10-16-35 RTP10-16-2,5-35-50-95-150	25/1	6.50
6030200001	NS 5	10	RPIT2.5-RPET2.5 YAZILI ETİKET FİYATI	50/1 50/1	6.50 8.50

Grup Etiketleri ve Durdurucular

6020102001	LB/1	19.5 mm	50/400	5.50
6020102002	LB/2	9.5 mm	50/1000	4.90
6020102003	ELB/1	9.5 mm	50/1200	4.50
6020101001	EB/1	İki Vidalı Durdurucu	50/1000	2.80
6020101002	EB/2	Üç Vidalı Durdurucu	50/1000	3.00
6020101003	EB/3	Tırnaklı Durdurucu	50/1000	3.10

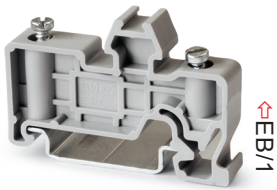

↕EB/1



↕EB/2

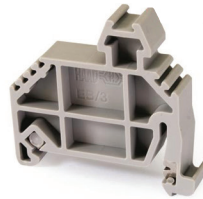

↕EB/3

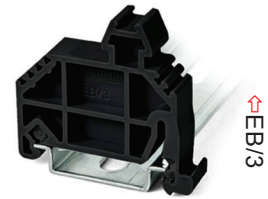

↕EB/3

www.raad.com.tr

LED SIGNAL LAMPS & DIN RAIL SOCKET OUTLET



RAAD  [®]
Confidence in Connection





Ray Montaj Topraklama Prizi

Sip. No	Tip	Akım (A)	Uygulama	Miktar Kutu	Fiyat TL / Adet
6080101001	DSO	16A		5/50	24.00
6080101002	DSO-LD	16A		5/50	36.00

LED Sinyal Lambaları

6070102401 6070102402 6070102403 6070102404 6070102405	IN-22 (Gövde)+Lamba Mavi-Sarı-Kırmızı Yeşil- Beyaz	10mA	Fi 22 mm.	25/250	7.64
6070140001	RSL-22 (Gövde)+Lamba Mavi-Sarı-Kırmızı Yeşil- Beyaz	10mA	Fi 22 mm.	25/250	10.10

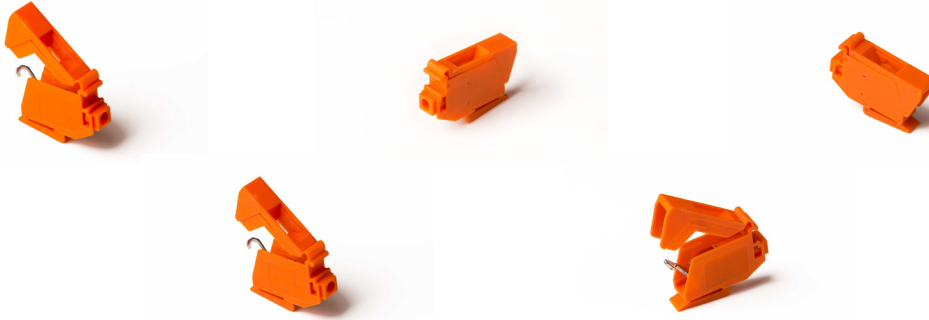

Trafo Klemensleri

Sip. No	Tip	Kesit	Akım - Voltaj	Miktar Kutu / Koli	Fiyat TL / Adet
6010499002	RT 4 (4 / Tekli)	4 mm ²	24 A - 800 V	200	2.50

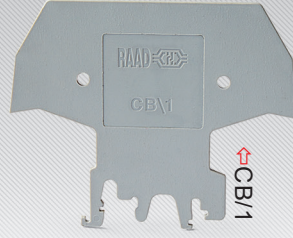

Ayrma Plakaları

Sip. No	Tip	Malzeme	Uygulama Klemens	Miktar Adet	Fiyat TL / Adet
6020301105	P-RTP4-6-10	PA 6,6	RTP2.5H-4-6-10	50	2.40
6020302001	P-DRTP4	PA 6,6	DRTP4	20	2.80

Genel Ayrma Plakası

6020305005	GP	PA 6,6	RTP16-50	20	3.20
------------	----	--------	----------	----	------

Alt Kapak

6020802001	CB/1	PA 6,6		10	3.20
------------	------	--------	--	----	------

Ayrma Dili

6020304001	SP 2,5-10	PA 6,6	RTP2,5-10	100	1.10
6020304004	SP-D4	PA 6,6	DRTP4	100	1.10
6020304002	SP 16-35	PA 6,6	RTP16-35	50	1.30

* RTP95-150, RST6, RTT6 hariç tüm klemenslerde kullanılabilir.





Nihayet Plakaları

Sip. No	Tip	Malzeme	Uygulama Klemens	Miktar Kutu/Koli	Fiyat TL / Adet
6020204101	EP-RDT4	PA 6,6	RDT4- R1- D1- TS	10/1000	2.20
6020202105	EP-RTP4-6-10	PA 6,6	RTP2.5H-4- 6-10	50/3000	1.40
6020203002	EP1-DRTP4	PA 6,6	DRTP4	20/500	3.50
6020203003	EP2-DRTP4	PA 6,6	DRTP4	20/400	3.50
6020203004	EP3-DRTP4	PA 6,6	DRTP4	20	3.50
6020201003	EP-RSTT6	PA 6,6	RSTT6- RSTU6	50	3.90
6020201004	EP-RSTP6	PA 6,6	RSTP6	50	3.90
6020203001	EP-DRTP 2.5/4	PA 6,6	DRTP2.5/4	20/500	3.20
6020201006	EP-RSTN6	PA 6,6	RSTN6	50/500	3.70

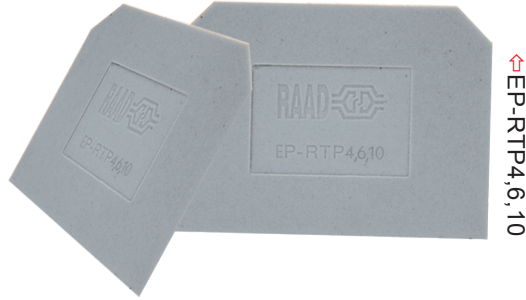

www.raad.com.tr

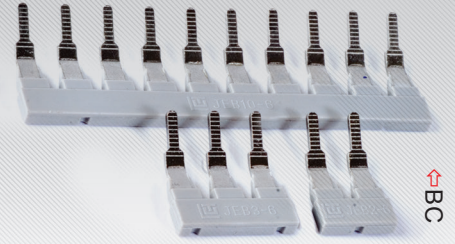

Tarak Köprü (BC)

Sip. No	Tip	Akım (A)	Uygulama Klemens	Miktar Kutu/Koli	Fiyat TL / Adet
6020504109	BC10-4	32	RTP4-RDT4	10/500	12.50
6020504102	BC3-4	32	RTP4-RDT4	50/2000	3.50
6020504101	BC2-4	32	RTP4-RDT4	50/2000	2.50
6020504209	BC10-D4	32	DRTP4-TRTP4	10/500	17.00
6020504202	BC3-D4	32	DRTP4-TRTP4	50/1000	6.50
6020504201	BC2-D4	32	DRTP4-TRTP4	50/1000	4.90

Push-in için Üst Köprüler

6020505001	BS2-2.5	24	RPIT2.5 - DPIT2.5 - RPIT1/2 - 2/2	100/2000	3.20
6020505002	BS3-2.5	24	RPIT2.5	100/2000	4.90
6020505009	BS10-2.5	32	RPIT2.5	10/500	14.50
6020505101	BS2-4	32	RPIT4	100	3.60
6020505102	BS3-4	32	RPIT4	100	5.10
6020505201	BS2-6	41	RPIT6	50	5.20

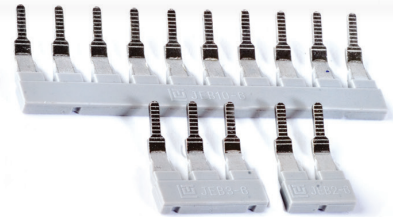

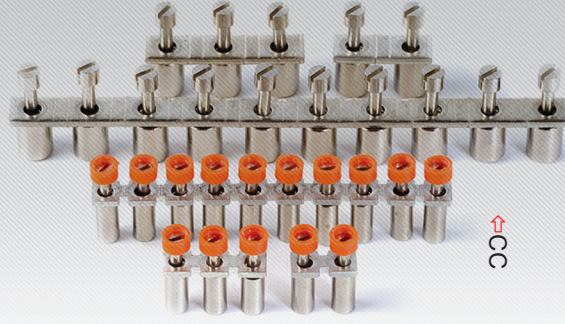

Üst Köprüler

Sip. No	Tip	Akım (A)	Uygulama Klemens	Miktar Kutu/Koli	Fiyat TL / Adet
6020502009	CC10-2,5	24	RTP2,5-H - DRTP2,5-4	10/500	18.00
6020502002	CC3-2,5	24	RTP2,5-H - DRTP2,5-4	50/2000	6.30
6020502001	CC2-2,5	24	RTP2,5-H - DRTP2,5-4	50/2000	4.20
6020502109	CC10-4	32	RTP4	10/500	13.50
6020502102	CC3-4	32	RTP4	50/500	4.10
6020502101	CC2-4	32	RTP4	50/500	3.00
6020503009	CC10-D4	32	DRTP4-TRTP4	10/500	17.30
6020503002	CC3-D4	32	DRTP4-TRTP4	50/1000	6.80
6020503001	CC2-D4	32	DRTP4-TRTP4	50/1000	4.80
6020502209	CC10-6	41	RTP-RST6-RTT6-RSTP6-RSTT6	10/500	15.60
6020502202	CC3-6	41	RTP-RST6-RTT6-RSTP6-RSTT6	50/500	5.00
6020502201	CC2-6	41	RTP-RST6-RTT6-RSTP6-RSTT6	50/500	3.10
6020502309	CC10-10	57	RTP10	10/500	17.00
6020502302	CC3-10	57	RTP10	50	5.30
6020502301	CC2-10	57	RTP10	50	3.90
6020502409	CC10-16	76	RTP16	10	30.00
6020502402	CC3-16	76	RTP16	20	9.60
6020502401	CC2-16	76	RTP16	20	7.10
6020502419	CC10-25	96	RTP25	10	35.00
6020502412	CC3-25	96	RTP25	20	13.00
6020502411	CC2-25	96	RTP25	20	9.50
6020502439	CC10-35	114	RTP35	10	38.50
6020502432	CC3-35	114	RTP35	20	16.70
6020502431	CC2-35	114	RTP35	20	9.00
6020502452	CC3-50	111	RTP50	10	30.50
6020502451	CC2-50	111	RTP50	10	20.50
6020502492	CC3-95	200	RTP95	10	55.50
6020502491	CC2-95	200	RTP95	10	39.50
6020502511	CC2-150	250	RTP150	10	68.00

www.raad.com.tr

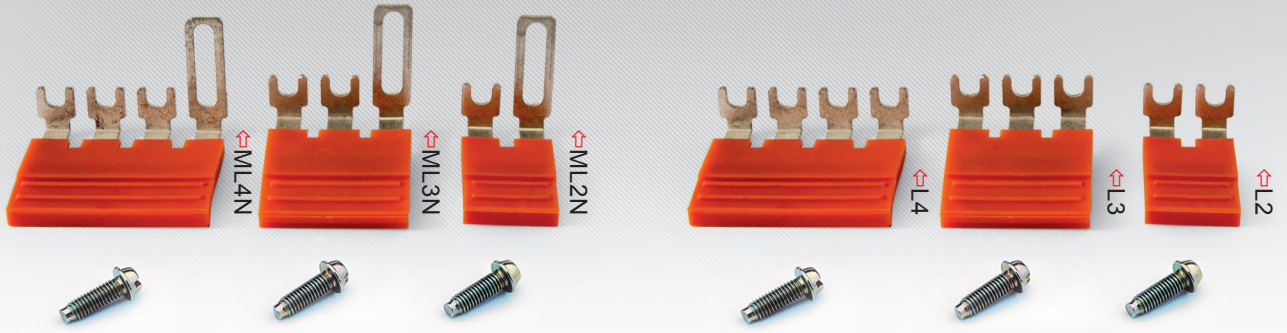

Tarak Köprü (ML)

Sip. No	Tip	Akım (A)	Uygulama Klemens	Miktar Adet	Fiyat TL / Adet
6020602001	ML2N	32	RST6-RTT6-RSTT6-RSTU6	50	3.80
6020602002	ML3N	32	RST6-RTT6-RSTT6-RSTU6	50	5.00
6020602003	ML4N	32	RST6-RTT6-RSTT6-RSTU6	50	7.60

Test Fişleri

6020402001	TS3/6/2.3		RTP4-DRTP4-RTP2.5H	50	2.30
6020402002	TS3/8/4		RTP 6,10,RSTT6, RSTU6	50	2.30
6020402003	TS3.5/8/4		RTP16	50	2.30
6020402004	TS4/8/4		RTP 25-RTP35	50	2.60
6020401005	TSS3/26/4 Gri-Mavi-KırmızıSarı ●●●●●		RST6-RTT6 RSTT6-RSTU6 RTP6,10	50	2.95
6020401004	L2	32	RSTN6	50	7.40
6020401002	L3	32	RSTN6	50	10.50
6020401003	L4	32	RSTN6	50	14.30



Confidence in Connection



Butonlar

Sip. No	Tip	Açıklama	Miktar Adet	Fiyat TL / Adet
700006	ESTR	Mantar Buton Stop	10	35.00
700007	FB-NC	Yaylı Stop Buton	10	24.00
700008	FB-NO	Yaylı Start Buton	10	24.00
700009	FBL-NC	Led Işıklı Stop Buton	10	38.00
700010	FBL-NO	Led Işıklı Start Buton	10	38.00
700011	DPBL	Işıklı İkiz Buton	10	58.00
700012	DPB	İkiz Buton	10	39.00
700013	SEI2	0-1 Kalıcı Mandal Butonu	10	33.00
700014	SES2	0-1 Kayıcı Mandal Butonu	10	33.00
700015	SEI3	1-0-2 Kalıcı Mandal Buton	10	36.00
700016	SES3	1-0-2 Kayıcı Mandal Buton	10	36.00
700017	NO-NC	Kontak Bloğu	200	7.00

FUSE SWITCH DISCONNECTOR

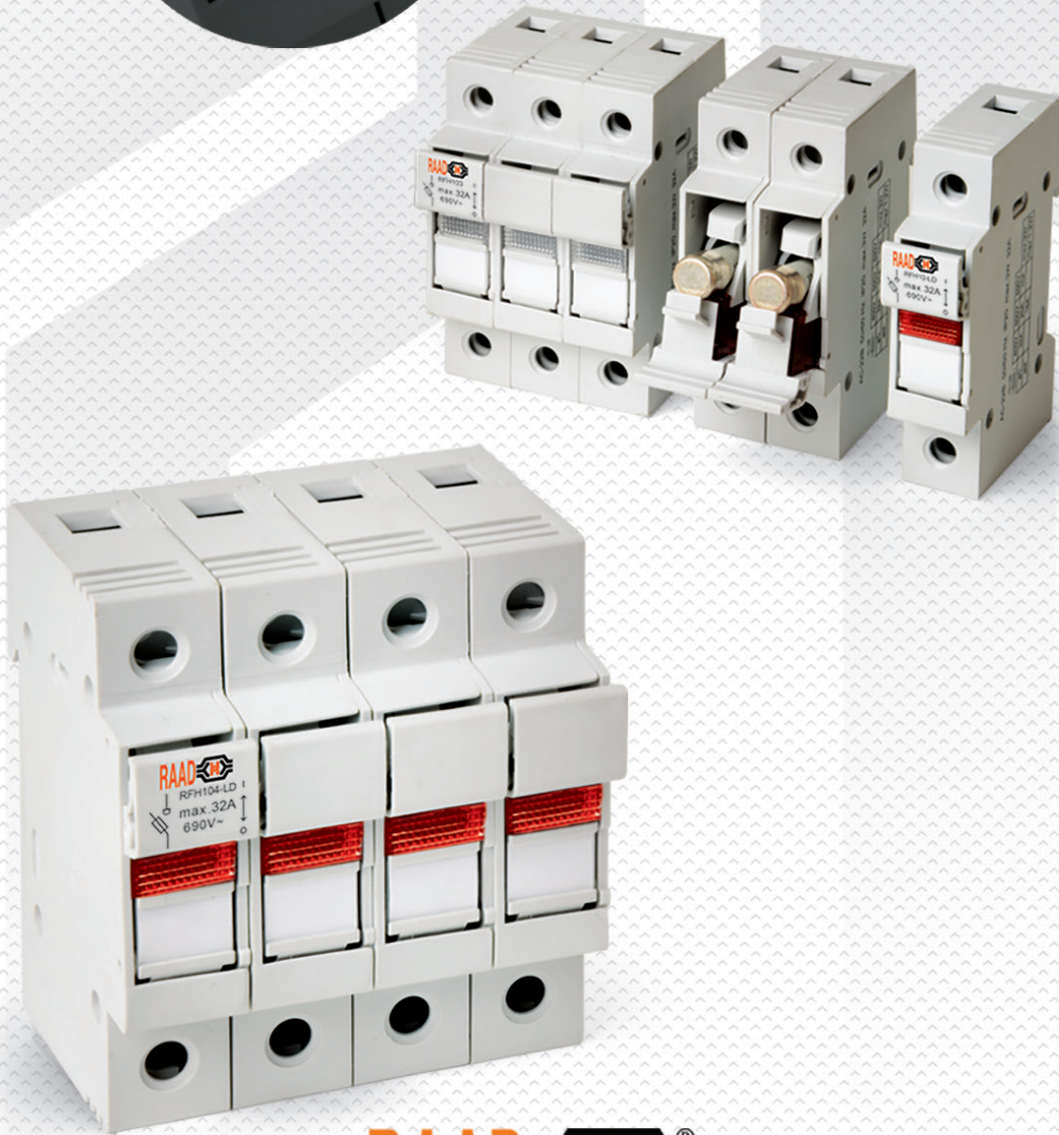

RAAD [®]
Confidence in Connection

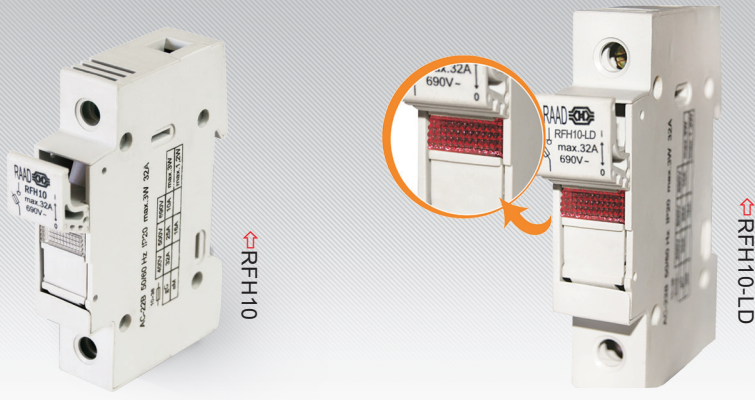

Sigorta Tutucu

Sip. No	Tip	Akım (A)	Açıklama	Miktar Kutu / Koli	Fiyat TL / Adet
6050101000	RFH10	32	Tek Kutuplu	12/120	18.00
6050101001	RFH10-LD	32	Tek Kutuplu	12/120	25.00
6050101002	RFH102	32	İki Kutuplu	6/60	32.50
6050101003	RFH103	32	Üç Kutuplu	4/40	46.00
6050201002	RFH102-LD	32	İki Kutuplu-Led	6/60	51.00
6050201003	RFH103-LD	32	Üç Kutuplu-Led	4/40	75.00
6050101004	RFH104	32	Dört Kutuplu	3/30	59.60
6050201004	RFH104-LD	32	Dört Kutuplu-Led	3/30	96.10

Silindirik Sigortalar

Sip. No	Tip	Gerilim (VAC)	Akım Değeri (A)	Miktar Adet	Fiyat TL / Adet
60120000	10x38 Fünysesiz	500	0.5-1-2-4-6-8-10-12-16-20-25	-	8.50
60120001	10x38 Fünysesiz	400	32	-	8.50

www.raad.com.tr

HIGH CURRENT TERMINAL BLOCKS

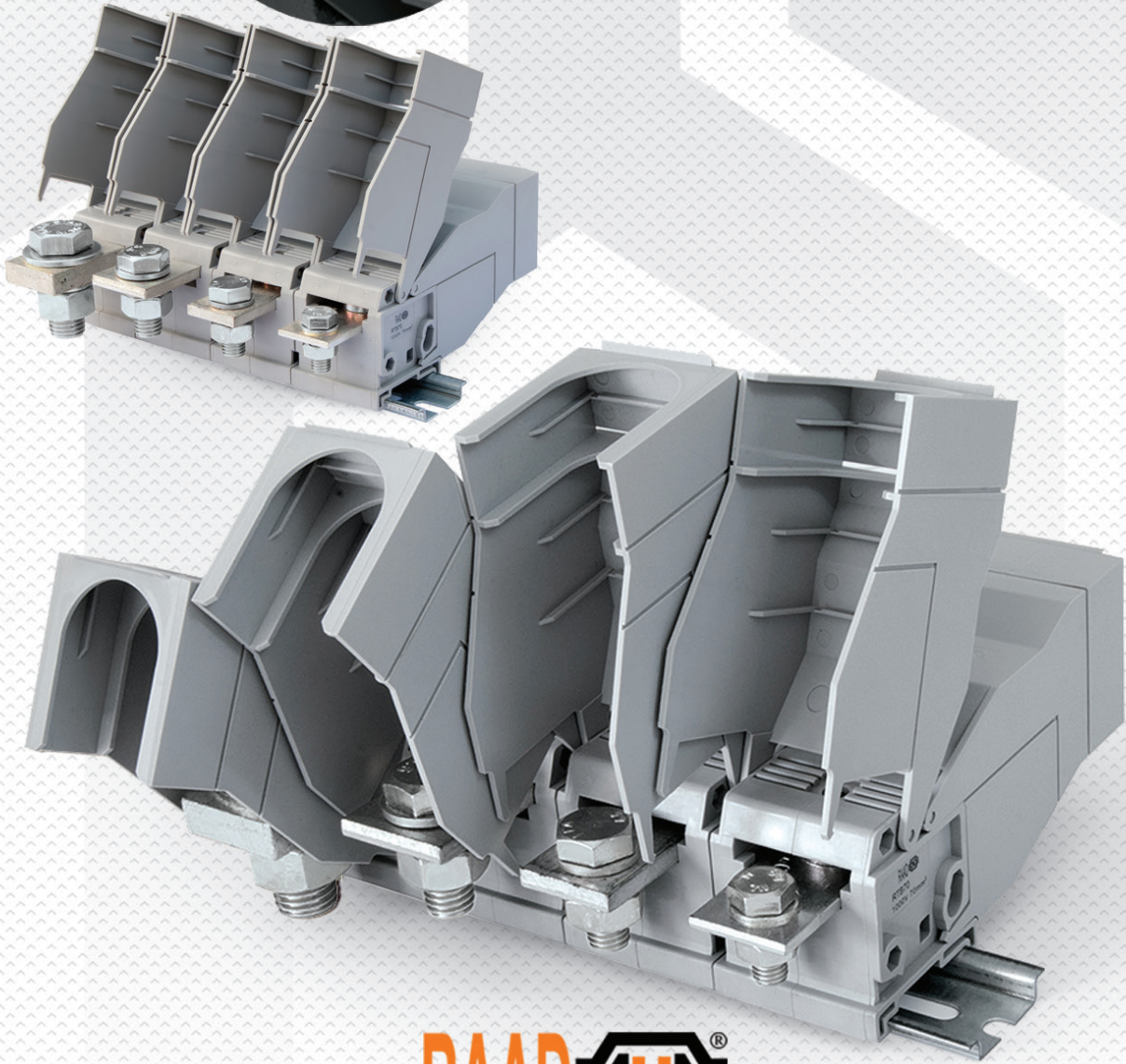

RAAD  [®]
Confidence in Connection

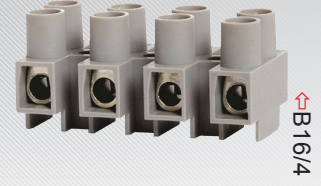
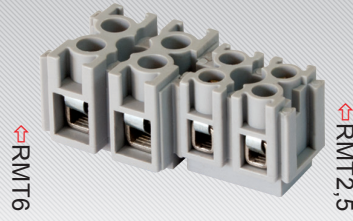
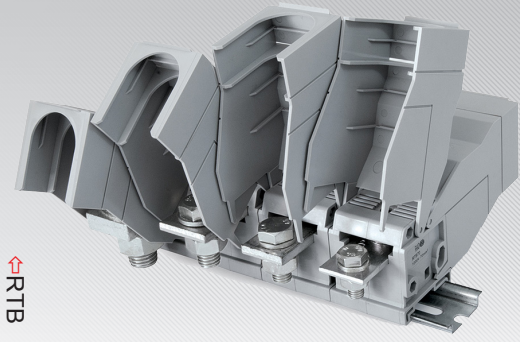

Baralı Klemensler

Sip. No	Tip	Akım (A)	Uygulama	Miktar Adet	Fiyat TL / Adet
6010501001	RTB70	192		5/25	69.00
6010502001	RTB95-120	232		5/25	80.00
6010503001	RTB150	309		5/25	110.00
6010504001	RTB185-240	415		4/20	155.00

Cihaz Sıra Klemensler

6010103001	RMT2.5	24	NS 6	100/1000	2.60
6010103002	RMT6	41	NS 6	60/600	4.30

Sıra Klemensler

60100306	B16/2	76		96/960	5.10
60100307	B16/3	76		32/512	11.25
60100308	B16/4	76		48/480	11.50
60100309	B16/5	76		32/320	11.80
60100310	B16/6	76		30/300	14.50
60100312	B16/8	76		24/240	19.00
60100314	B16/10	76		16/160	23.50
60100315	B16/12	76		8/128	28.50

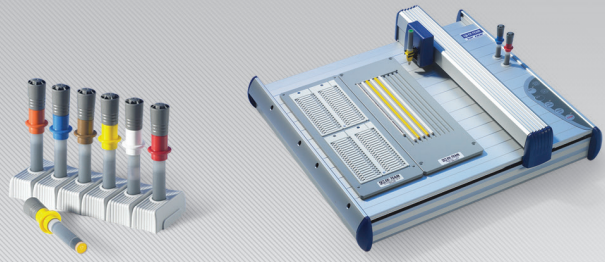

Plotter Yazıcılar

Sip. No	Tip	Uygulama	Miktar Adet	Fiyat TL / Adet
701110	Raad Plotter	NS5 - NS6 - NS8 - NS10	1	Sorunuz
701112	Raad Plot Kalem	0.18-0.25-0.35-0.50-0.70-1 mm	1	Sorunuz
701114	Raad Yazılım CD	Raad Plotter	1	Sorunuz



Montaj Ray Makası

Sip. No	Tip	Uygulama	Miktar Adet	Fiyat TL / Adet
701122	Ray Kesme Makası	35x7.5-35x15	1	Sorunuz

Termal Yazıcılar

Sip. No	Tip	Uygulama	Miktar Adet	Fiyat TL / Adet
701116	Termal Yazıcı	Termal Etiketleme	1	Sorunuz
701118	Termal Ribbon	25 mm x 90 m	1	145.00
701120	Termal Etiket	2 x 20 mt	1	240.00





Kaçak Akım Koruma Rölesi P2

Sip. No	Tip	Akım (A)	Açıklama	Miktar Adet	Fiyat TL / Adet
60804501	RA2*25A 30MA	25	İki Kutuplu	6	197.00
60804502	RA2*32A 30MA	32	İki Kutuplu	6	197.00
60804503	RA2*40A 30MA	40	İki Kutuplu	6	197.00
60804504	RA2*63A 30MA	63	İki Kutuplu	6	231.00

Kaçak Akım Koruma Rölesi P4

Sip. No	Tip	Akım (A)	Açıklama	Miktar Adet	Fiyat TL / Adet
60804531	RA4*25A 30MA	25	Dört Kutuplu	3	356.00
60804532	RA4*32A 30MA	32	Dört Kutuplu	3	356.00
60804533	RA4*40A 030	40	Dört Kutuplu	3	356.00
60804534	RA4*63A 30MA	63	Dört Kutuplu	3	370.00

www.raad.com.tr



6kA



6kA



6kA

Otomatik Sigortalar 6 kA

Sip. No	Tip	Akım (A)	Açıklama	Miktar Kutu/Koli	Fiyat TL / Adet
60801161	MA 1 C1	1	1*1A C Tipi 6 kA	96/12	28.00
60801162	MA 1 C2	2	1*2A C Tipi 6 kA	96/12	28.00
60801163	MA 1 C3	3	1*3A C Tipi 6 kA	96/12	28.00
60801164	MA 1 C4	4	1*4A C Tipi 6 kA	96/12	28.00
60801165	MA 1 C6	6	1*5A C Tipi 6 kA	96/12	28.00
60801166	MA 1 C10	10	1*10A C Tipi 6 kA	96/12	28.00
60801168	MA 1 C16	16	1*16A C Tipi 6 kA	96/12	28.00
60801169	MA 1 C20	20	1*20A C Tipi 6 kA	96/12	28.00
60801170	MA 1 C25	25	1*25A C Tipi 6 kA	96/12	28.00
60801171	MA 1 C32	32	1*32A C Tipi 6 kA	96/12	28.00
60801172	MA 1 C40	40	1*40A C Tipi 6 kA	96/12	28.00
60801173	MA 1 C50	50	1*50A C Tipi 6 kA	96/12	29.00
60801174	MA 1 C63	63	1*63A C Tipi 6 kA	96/12	29.00
60801261	MA 2 C1	1	2*1A C Tipi 6 kA	48/6	62.00
60801262	MA 2 C2	2	2*2A C Tipi 6 kA	48/6	62.00
60801263	MA 2 C3	3	2*3A C Tipi 6 kA	48/6	62.00
60801264	MA 2 C4	4	2*4A C Tipi 6 kA	48/6	62.00
60801265	MA 2 C6	6	2*5A C Tipi 6 kA	48/6	62.00
60801266	MA 2 C10	10	2*10A C Tipi 6 kA	48/6	62.00
60801268	MA 2 C16	16	2*16A C Tipi 6 kA	48/6	62.00
60801269	MA 2 C20	20	2*20A C Tipi 6 kA	48/6	62.00
60801270	MA 2 C25	25	2*25A C Tipi 6 kA	48/6	62.00
60801271	MA 2 C32	32	2*32A C Tipi 6 kA	48/6	62.00
60801272	MA 2 C40	40	2*40A C Tipi 6 kA	48/6	62.00
60801273	MA 2 C50	50	2*50A C Tipi 6 kA	48/6	65.00
60801274	MA 2 C63	63	2*63A C Tipi 6 kA	48/6	65.00
60801361	MA 3 C1	1	3*1A C Tipi 6 kA	32/4	90.00
60801362	MA 3 C2	2	3*2A C Tipi 6 kA	32/4	90.00
60801363	MA 3 C3	3	3*3A C Tipi 6 kA	32/4	90.00
60801364	MA 3 C4	4	3*4A C Tipi 6 kA	32/4	90.00
60801365	MA 3 C6	6	3*5A C Tipi 6 kA	32/4	90.00
60801366	MA 3 C10	10	3*10A C Tipi 6 kA	32/4	90.00
60801368	MA 3 C16	16	3*16A C Tipi 6 kA	32/4	90.00
60801369	MA 3 C20	20	3*20A C Tipi 6 kA	32/4	90.00
60801370	MA 3 C25	25	3*25A C Tipi 6 kA	32/4	90.00
60801371	MA 3 C32	32	3*32A C Tipi 6 kA	32/4	90.00
60801372	MA 3 C40	40	3*40A C Tipi 6 kA	32/4	90.00
60801373	MA 3 C50	50	3*50A C Tipi 6 kA	32/4	93.00
60801374	MA 3 C63	63	3*63A C Tipi 6 kA	32/4	93.00



Confidence in Connection



↑10kA



↑10kA



↑10kA

Otomatik Sigortalar 10 kA

Sip. No	Tip	Akım (A)	Açıklama	Miktar Kutu/Koli	Fiyat TL / Adet
60801181	MA 1 C1	1	1*1A C Tipi 10 kA	96/12	34.00
60801182	MA 1 C2	2	1*2A C Tipi 10 kA	96/12	34.00
60801183	MA 1 C3	3	1*3A C Tipi 10 kA	96/12	34.00
60801184	MA 1 C4	4	1*4A C Tipi 10 kA	96/12	34.00
60801185	MA 1 C6	6	1*5A C Tipi 10 kA	96/12	34.00
60801186	MA 1 C10	10	1*10A C Tipi 10 kA	96/12	34.00
60801188	MA 1 C16	16	1*16A C Tipi 10 kA	96/12	34.00
60801189	MA 1 C20	20	1*20A C Tipi 10 kA	96/12	34.00
60801190	MA 1 C25	25	1*25A C Tipi 10 kA	96/12	34.00
60801191	MA 1 C32	32	1*32A C Tipi 10 kA	96/12	34.00
60801192	MA 1 C40	40	1*40A C Tipi 10 kA	96/12	34.00
60801193	MA 1 C50	50	1*50A C Tipi 10 kA	96/12	36.00
60801194	MA 1 C63	63	1*63A C Tipi 10 kA	96/12	36.00
60801281	MA 2 C1	1	2*1A C Tipi 10 kA	48/6	78.00
60801282	MA 2 C2	2	2*2A C Tipi 10 kA	48/6	78.00
60801283	MA 2 C3	3	2*3A C Tipi 10 kA	48/6	78.00
60801284	MA 2 C4	4	2*4A C Tipi 10 kA	48/6	78.00
60801285	MA 2 C6	6	2*5A C Tipi 10 kA	48/6	78.00
60801286	MA 2 C10	10	2*10A C Tipi 10 kA	48/6	78.00
60801288	MA 2 C16	16	2*16A C Tipi 10 kA	48/6	78.00
60801289	MA 2 C20	20	2*20A C Tipi 10 kA	48/6	78.00
60801290	MA 2 C25	25	2*25A C Tipi 10 kA	48/6	78.00
60801291	MA 2 C32	32	2*32A C Tipi 10 kA	48/6	78.00
60801292	MA 2 C40	40	2*40A C Tipi 10 kA	48/6	78.00
60801293	MA 2 C50	50	2*50A C Tipi 10 kA	48/6	81.00
60801294	MA 2 C63	63	2*63A C Tipi 10 kA	48/6	81.00
60801381	MA 3 C1	1	3*1A C Tipi 10 kA	32/4	112.00
60801382	MA 3 C2	2	3*2A C Tipi 10 kA	32/4	112.00
60801383	MA 3 C3	3	3*3A C Tipi 10 kA	32/4	112.00
60801384	MA 3 C4	4	3*4A C Tipi 10 kA	32/4	112.00
60801385	MA 3 C6	6	3*5A C Tipi 10 kA	32/4	112.00
60801386	MA 3 C10	10	3*10A C Tipi 10 kA	32/4	112.00
60801388	MA 3 C16	16	3*16A C Tipi 10 kA	32/4	112.00
60801389	MA 3 C20	20	3*20A C Tipi 10 kA	32/4	112.00
60801390	MA 3 C25	25	3*25A C Tipi 10 kA	32/4	112.00
60801391	MA 3 C32	32	3*32A C Tipi 10 kA	32/4	112.00
60801392	MA 3 C40	40	3*40A C Tipi 10 kA	32/4	112.00
60801393	MA 3 C50	50	3*50A C Tipi 10 kA	32/4	118.00
60801394	MA 3 C63	63	3*63A C Tipi 10 kA	32/4	118.00

BÖLGELERİMİZ ve BAYİLERİMİZ

ANKARA

ATS KABLO ENERJİ ELEKTRİK LTD. ŞTİ.
www.atskablo.com / (0312) 394 47 85

SERBAY ELEKTRİK LTD. ŞTİ.
www.serbayelektrik.com.tr / (0312) 386 19 34

TBA ENERJİ LTD. ŞTİ.
www.tbaenerji.com.tr / (0312) 566 39 39

ULTRA GRUP ELEKTRİK ENERJİ LTD. ŞTİ.
www.ultragrup.net / (0312) 394 45 94

İSTANBUL

PAVEL MÜHENDİSLİK LTD. ŞTİ.
www.pavel.com.tr / (0216) 471 20 42

İZMİR

MEGASİM ELEKTRİK LTD. ŞTİ.
www.megasimelektrik.com.tr / (0232) 459 54 54

SKALA ENDÜSTRİYEL LTD. ŞTİ.
www.skala.gen.tr / (0232) 457 30 57

KONYA

KONYA ELMAK ELEKTRİK A.Ş.
www.konyaelmak.com.tr / (0332) 345 18 11

ANTALYA

AKSİYON OTOMASYON SAN. TİC. LTD. ŞTİ.
www.aksiyonelk.com.tr / (0242) 321 85 85

BURSA

ARTI ELEKTROMARKET LTD. ŞTİ.
www.artielektromarket.com.tr / (0224) 443 40 16

AYNES ELEKTRİK LTD. ŞTİ.
www.ayneselektrik.com.tr / (0224) 443 15 45

DURPASAN ELEKTRİK LTD. ŞTİ.
www.durpasan.com.tr
Merkez: (0224) 252 96 12 / Şube: (0224) 441 35 35

ESKİŞEHİR

BEKAS ELEKTRİK LTD. ŞTİ.
www.bekaselektrik.com.tr / (0222) 220 58 00

CES ELEKTRİK LTD. ŞTİ.
www.ceselektrik.com / (0222) 240 34 34

RAAD
Confidence in Connection